

ROLLING DOORS

GROUP : 22.A

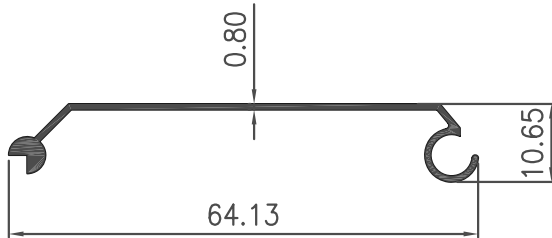

Section No : 7001

W = 0.207 KG/M
P = 169.69 MM

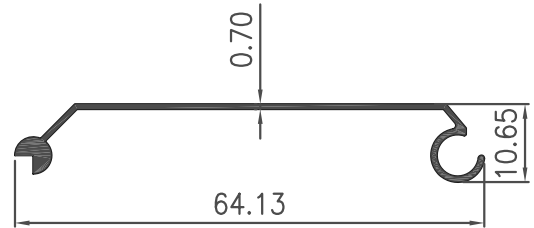

Section No : 7001r

W = 0.191 KG/M
P = 169.95 MM

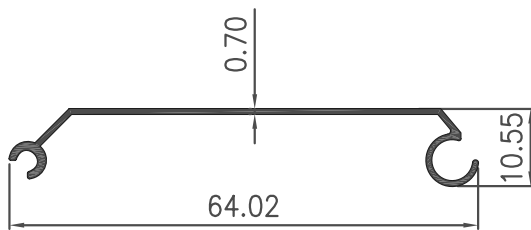

Section No : 7001A

W = 0.173 KG/M
P = 172.82 MM

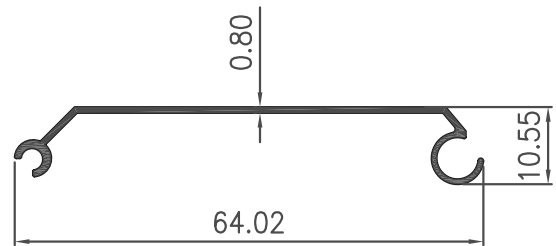

Section No : 7001AT

W = 0.190 KG/M
P = 172.37 MM

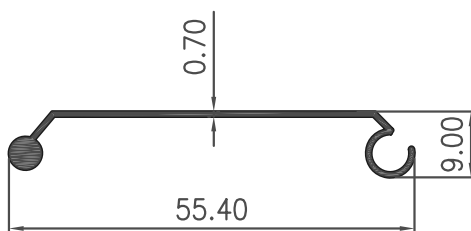

Section No : 7014

W = 0.169 KG/M
P = 146.10 MM

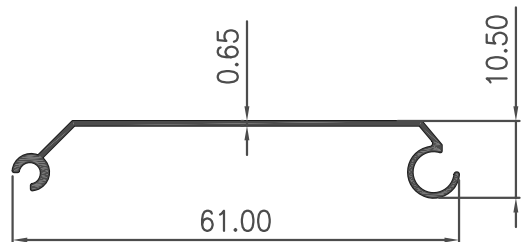

Section No : 7077

W = 0.158 KG/M
P = 166.95 MM

ROLLING DOORS

GROUP : 22.B

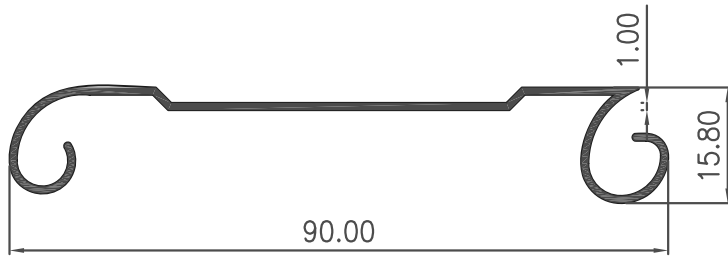

Section No : 7020

W = 0.382 KG/M

P = 283.47 MM

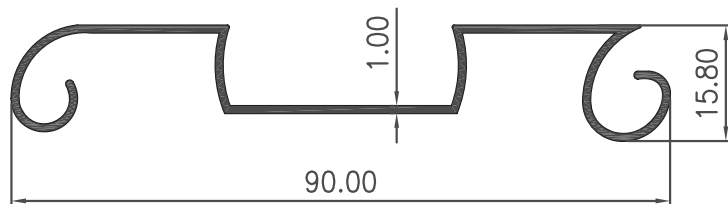

Section No : 7021

W = 0.436 KG/M

P = 323.03 MM

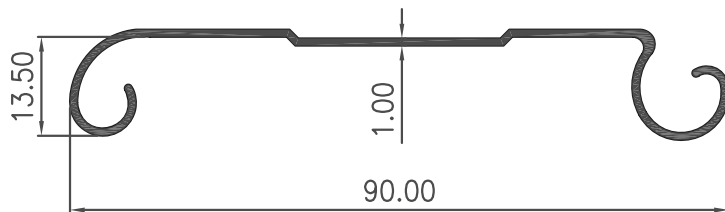

Section No : 7019

W = 0.365 KG/M

P = 268.12 MM

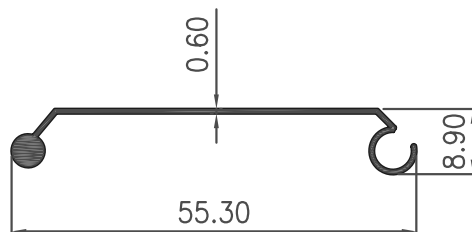

Section No : 7078

W = 0.151 KG/M

P = 146.27 MM

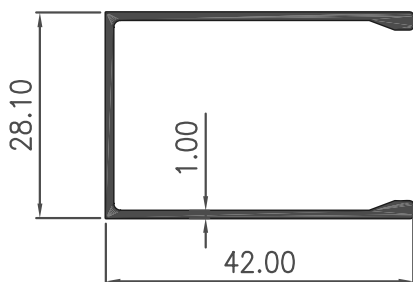

Section No : 7002

W = 0.329 KG/M

P = 223.55 MM

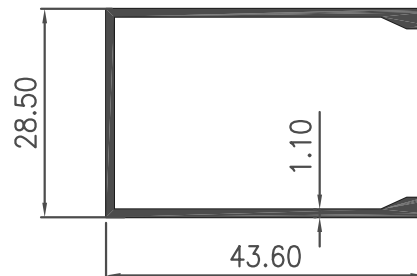

Section No : 7015

W = 0.375 KG/M

P = 232.24 MM

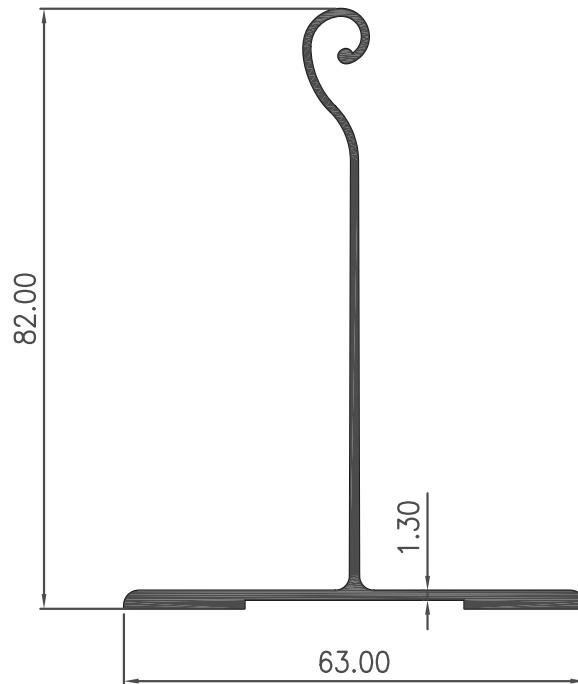

Section No : 7022

W = 0.612 KG/M

P = 318.35 MM

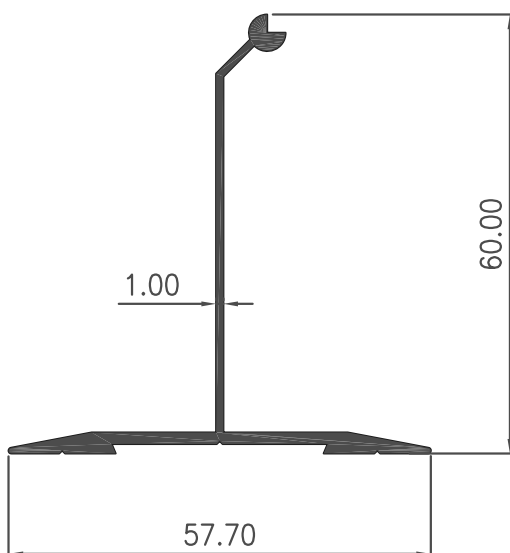

Section No : 7017

W = 0.472 KG/M

P = 246.59 MM

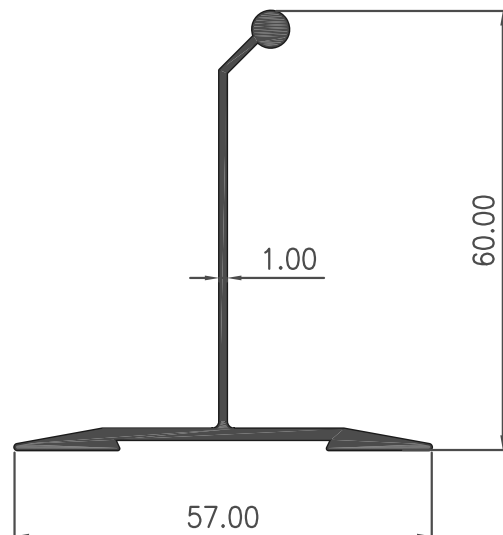

Section No : 7003

W = 0.471 KG/M

P = 242.30 MM

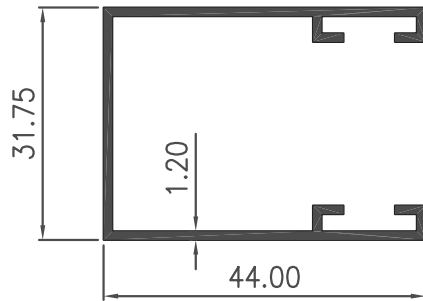

Section No : 7023

W = 0.466 KG/M

P = 289.10 MM

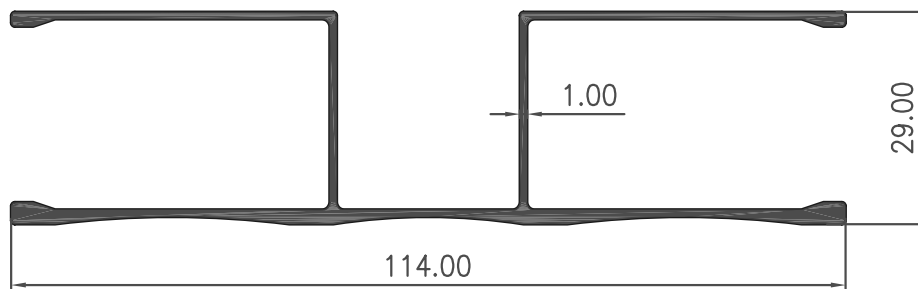

Section No : 7004

W = 0.888 KG/M

P = 514.20 MM

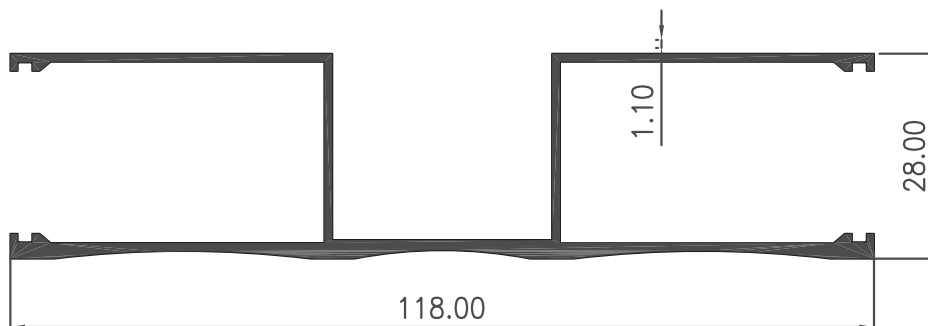

Section No : 7016

W = 0.970 KG/M

P = 530.82 MM

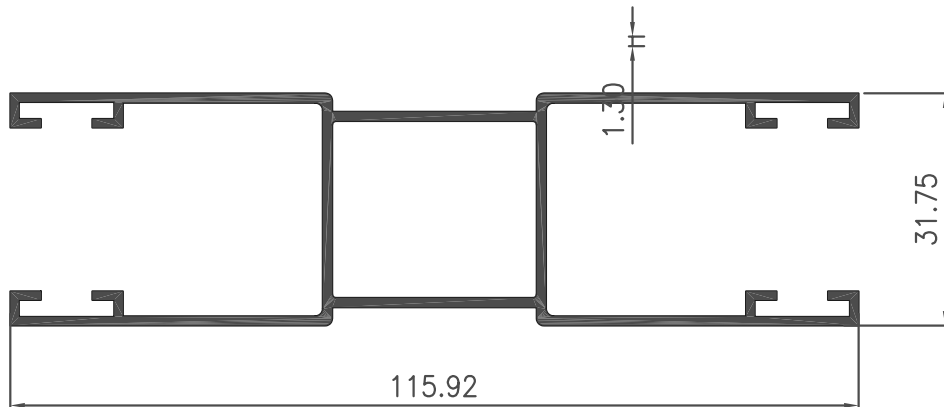

Section No : 7024

W = 1.175 KG/M
P = 575.91 MM

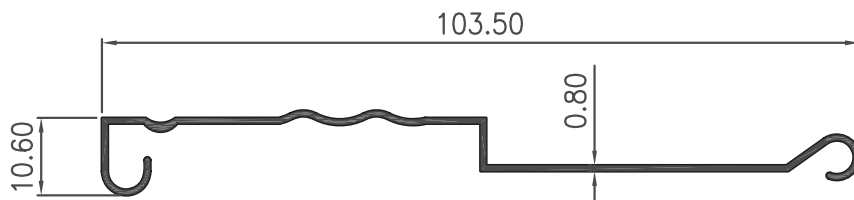

Section No : 7091R

W = 0.299 KG/M
P = 274.64 MM

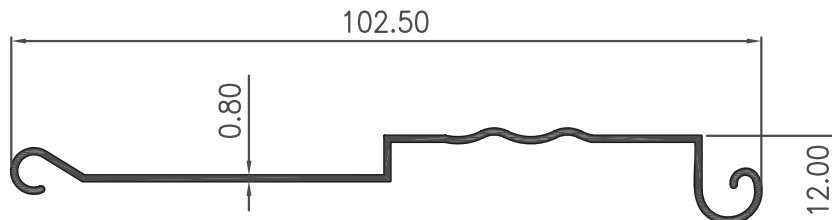

Section No : 7090

W = 0.291 KG/M
P = 269.93 MM