

SHOW CASES

GROUP : 19.A

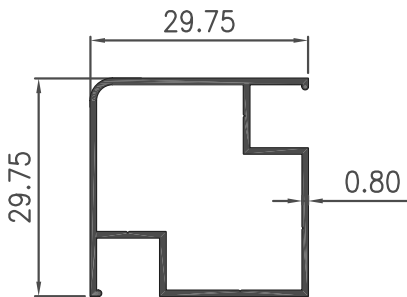

**Section No : 5007**

W = 0.285 KG/M  
P = 151.83 MM

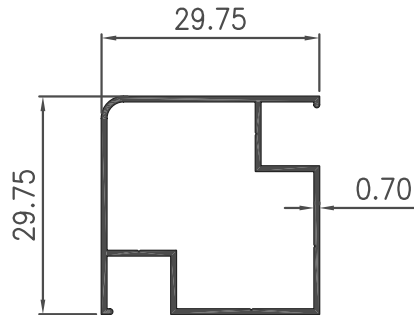

**Section No : 5007R**

W = 0.251 KG/M  
P = 152.31 MM

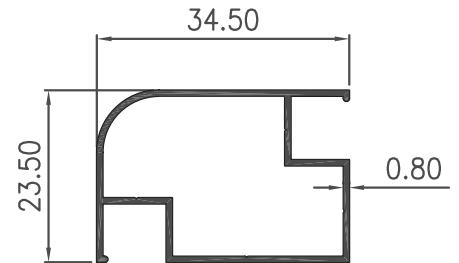

**Section No : 5008**

W = 0.274 KG/M  
P = 146.47 MM

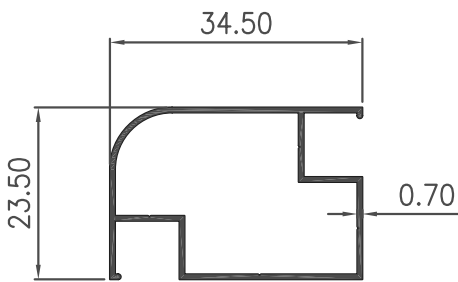

**Section No : 5008R**

W = 0.241 KG/M  
P = 146.95 MM

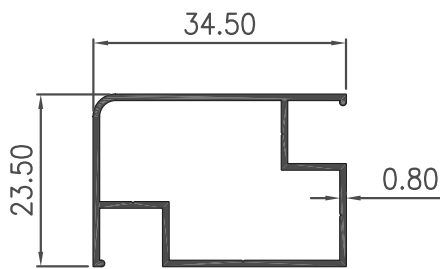

**Section No : 5009**

W = 0.279 KG/M  
P = 148.83 MM

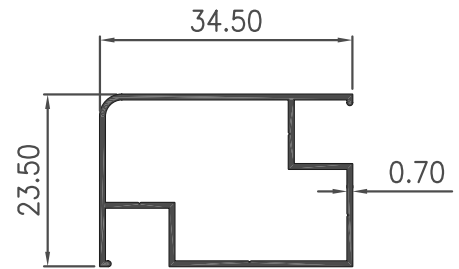

**Section No : 5009R**

W = 0.245 KG/M  
P = 149.31 MM

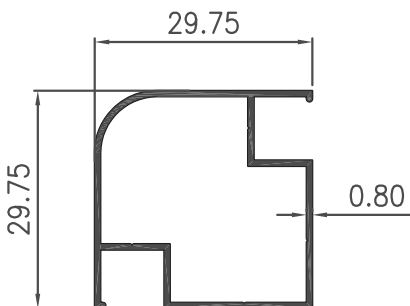

**Section No : 5010**

W = 0.280 KG/M  
P = 149.47 MM

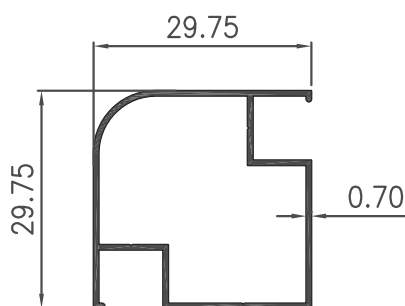

**Section No : 5010R**

W = 0.247 KG/M  
P = 149.47 MM

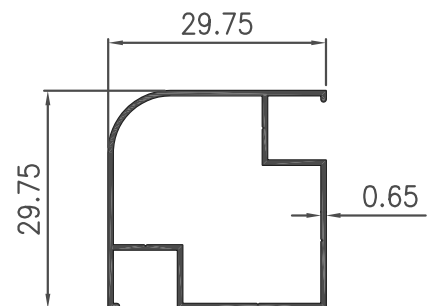

**Section No : 5010R1**

W = 0.229 KG/M  
P = 150.19 MM

SHOW CASES

GROUP : 19.B

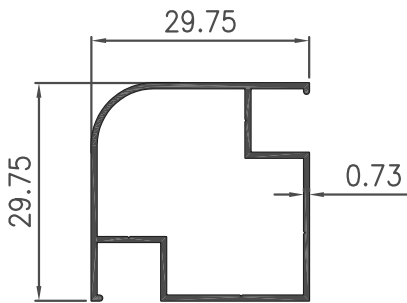

**Section No : 5010RT**

W = 0.257 KG/M  
P = 149.81 MM

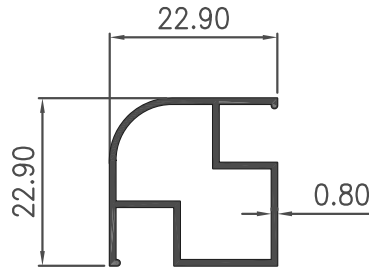

**Section No : 5011**

W = 0.221 KG/M  
P = 121.67 MM

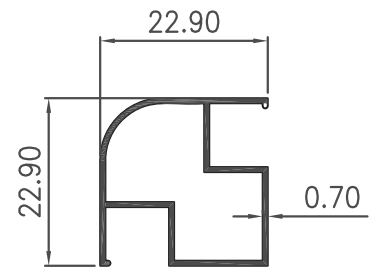

**Section No : 5011R**

W = 0.195 KG/M  
P = 122.15 MM

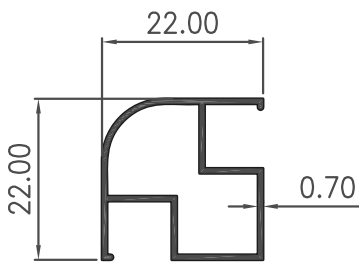

**Section No : 5011B**

W = 0.188 KG/M  
P = 118.95 MM

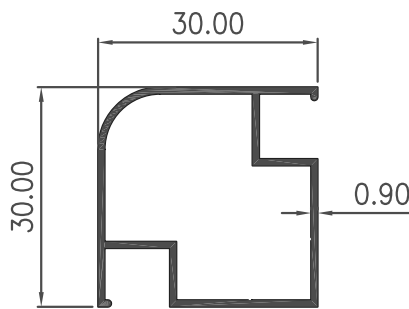

**Section No : 5012**

W = 0.318 KG/M  
P = 151.18 MM

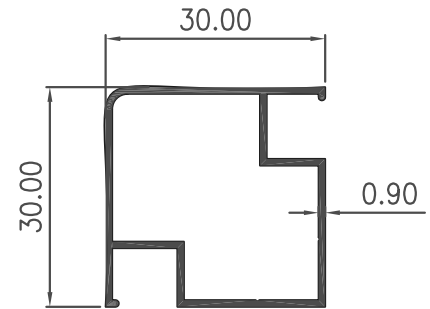

**Section No : 5013**

W = 0.324 KG/M  
P = 153.54 MM

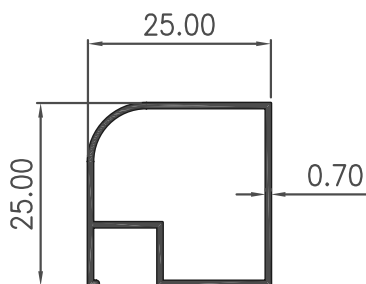

**Section No : 5015**

W = 0.195 KG/M  
P = 113.87 MM

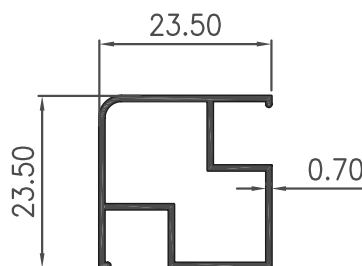

**Section No : 5019**

W = 0.204 KG/M  
P = 127.31 MM

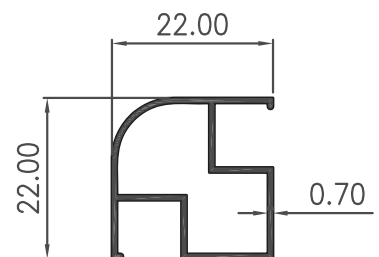

**Section No : 5020**

W = 0.188 KG/M  
P = 118.95 MM

SHOW CASES

GROUP : 19.C

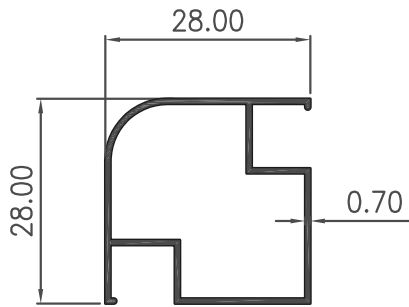

Section No : 5021

W = 0.234 KG/M  
P = 142.95 MM

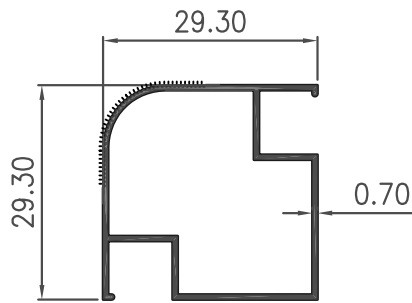

Section No : 5022

W = 0.239 KG/M  
P = 154.13 MM

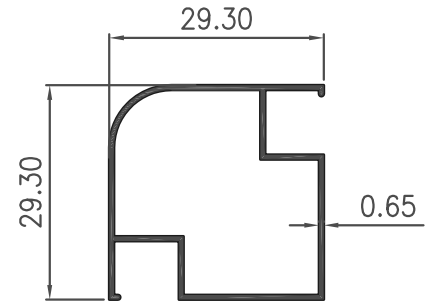

Section No : 5026

W = 0.227 KG/M  
P = 148.39 MM

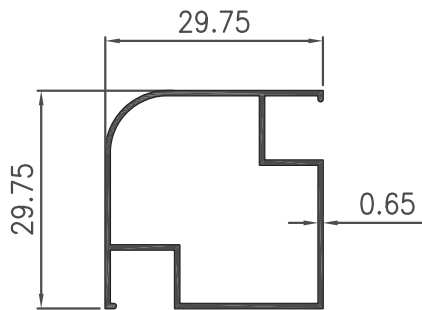

Section No : 5027

W = 0.230 KG/M  
P = 150.19 MM

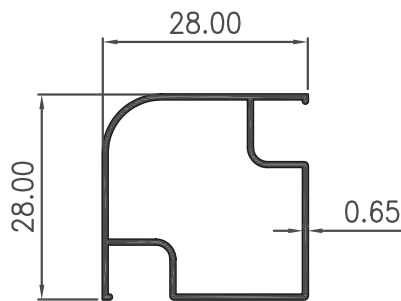

Section No : 5028

W = 0.211 KG/M  
P = 138.05 MM

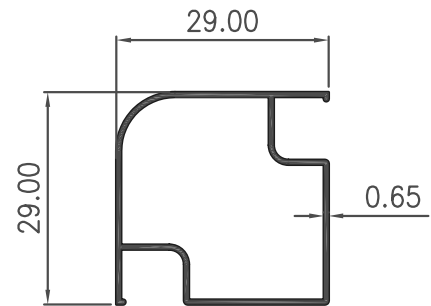

Section No : 5029

W = 0.218 KG/M  
P = 142.05 MM

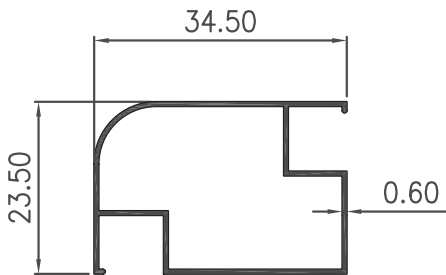

Section No : 5040

W = 0.208 KG/M  
P = 147.44 MM

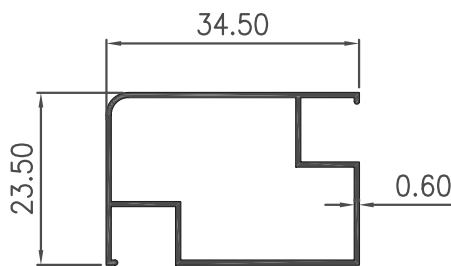

Section No : 5041

W = 0.212 KG/M  
P = 149.80 MM

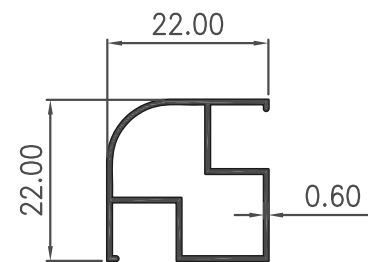

Section No : 5042

W = 0.162 KG/M  
P = 119.44 MM

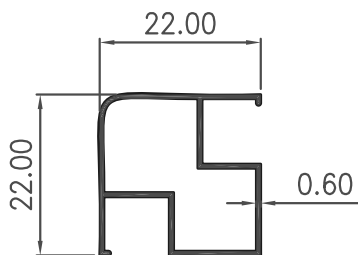

Section No : 5043

W = 0.166 KG/M  
P = 121.80 MM

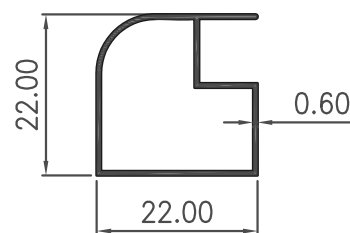

Section No : 5049

W = 0.147 KG/M  
P = 100.31 MM

SHOW CASES

GROUP : 19.D

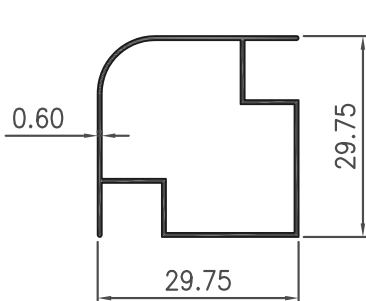

**Section No : 5053**  
W = 0.210 KG/M  
P = 146.84 MM

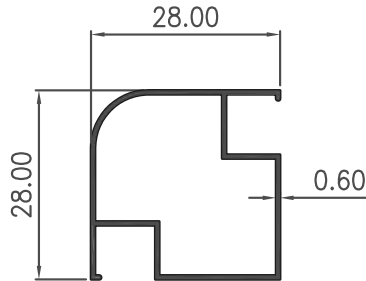

**Section No : 5044**  
W = 0.201 KG/M  
P = 143.44 MM

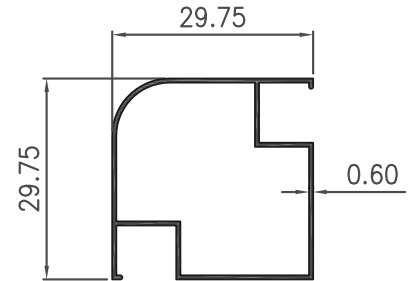

**Section No : 5045**  
W = 0.213 KG/M  
P = 150.44 MM

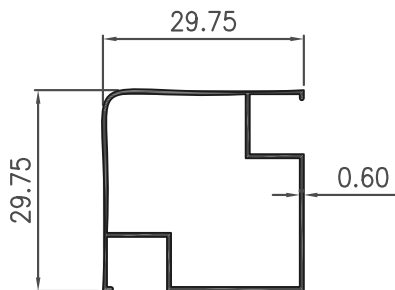

**Section No : 5046**  
W = 0.216 KG/M  
P = 152.80 MM

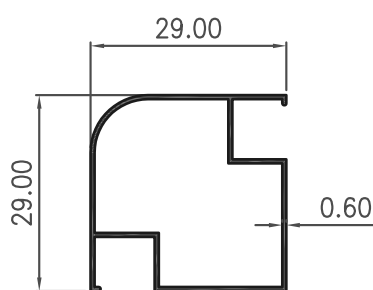

**Section No : 5047**  
W = 0.208 KG/M  
P = 147.44 MM

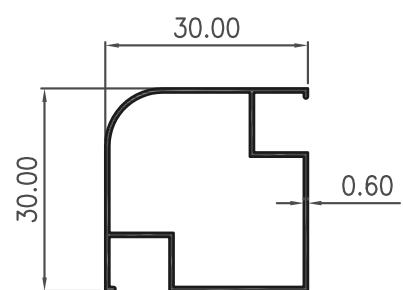

**Section No : 5048**  
W = 0.214 KG/M  
P = 151.44 MM

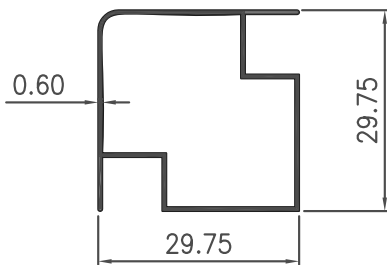

**Section No : 5054**  
W = 0.213 KG/M  
P = 149.20 MM

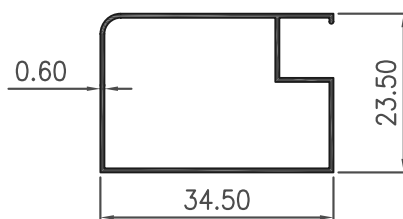

**Section No : 5050**  
W = 0.197 KG/M  
P = 132.25 MM

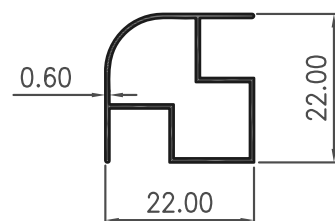

**Section No : 5052**  
W = 0.159 KG/M  
P = 115.84 MM

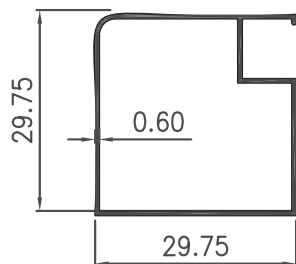

**Section No : 26515**  
W = 0.202 KG/M  
P = 135.25 MM

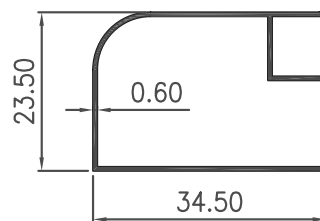

**Section No : 26516**  
W = 0.193 KG/M  
P = 129.29 MM

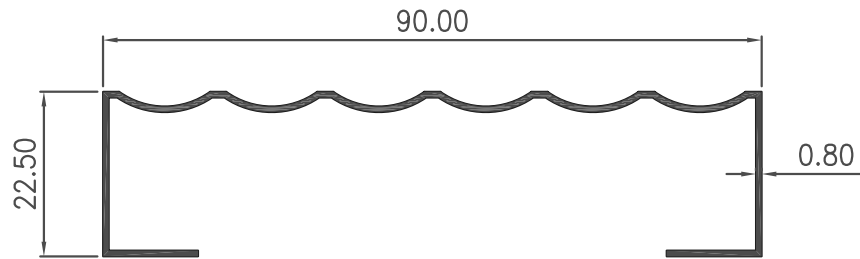

**Section No : 5005**

W = 0.353 KG/M

P = 327.10 MM

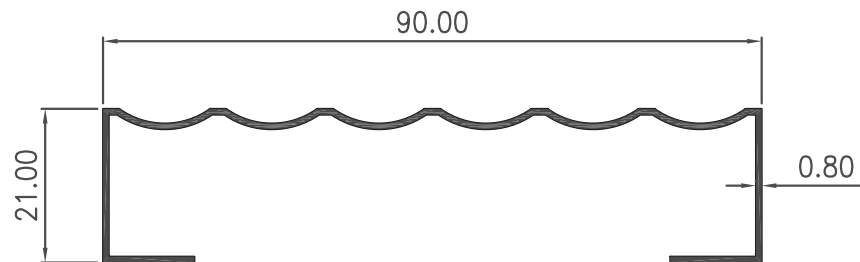

**Section No : 5005B**

W = 0.344 KG/M

P = 319.10 MM

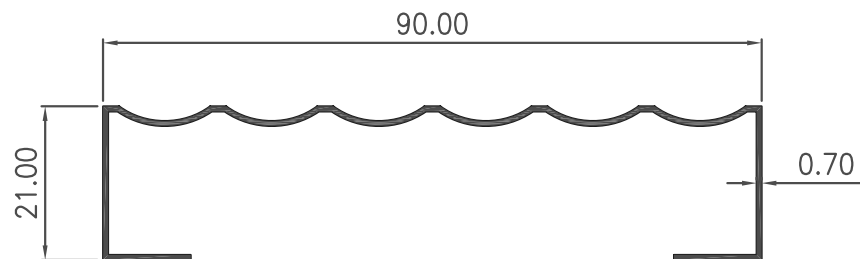

**Section No : 5005Br**

W = 0.300 KG/M

P = 317.73 MM

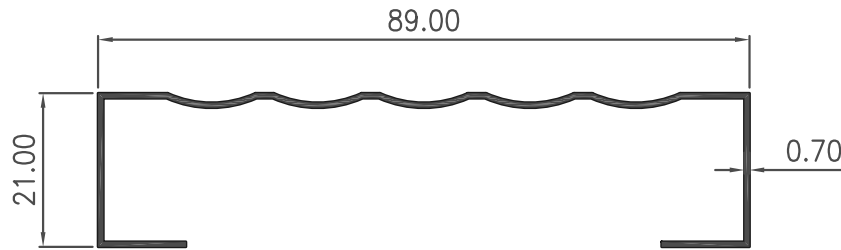

**Section No : 5016**

W = 0.291 KG/M

P = 309.48 MM

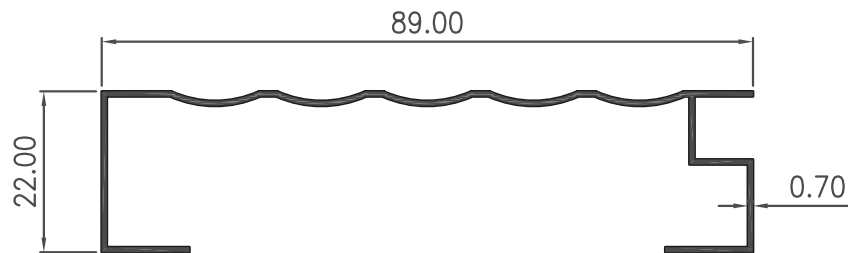

**Section No : 5018**

W = 0.311 KG/M

P = 329.48 MM

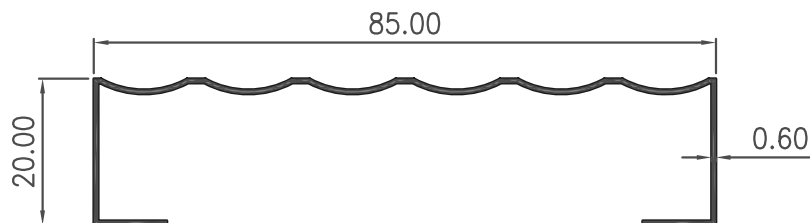

**Section No : 5038**

W = 0.237 KG/M

P = 292.38 MM

SHOW CASES

GROUP : 19.G

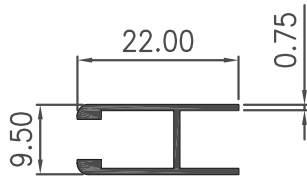

**Section No : 5004**  
W = 0.124 KG/M  
P = 109.01 MM

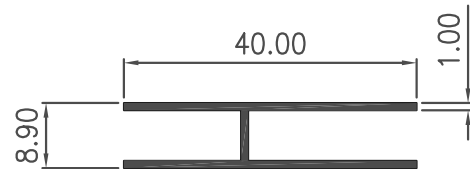

**Section No : 5006**  
W = 0.235 KG/M  
P = 175.80 MM

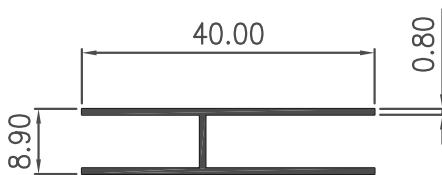

**Section No : 5006R**  
W = 0.189 KG/M  
P = 176.70 MM

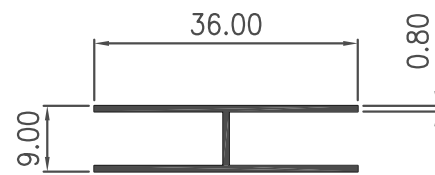

**Section No : 5014**  
W = 0.172 KG/M  
P = 160.40 MM

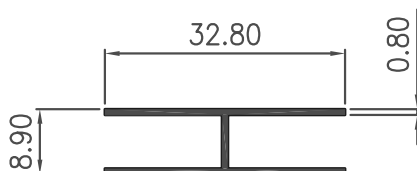

**Section No : 5017**  
W = 0.158 KG/M  
P = 147.40 MM

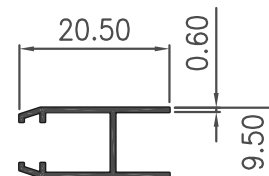

**Section No : 5031**  
W = 0.087 KG/M  
P = 107.61 MM

SHOW CASES

GROUP : 19.H

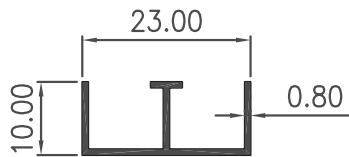

**Section No : 5002**  
W = 0.117 KG/M  
P = 109.80 MM

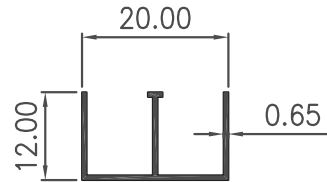

**Section No : 5002B**  
W = 0.098 KG/M  
P = 112.10 MM

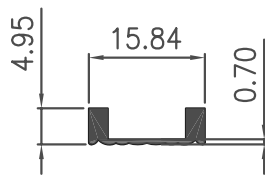

**Section No : 5003**  
W = 0.088 KG/M  
P = 51.09 MM

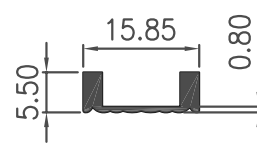

**Section No : 5003B**  
W = 0.096 KG/M  
P = 53.29 MM

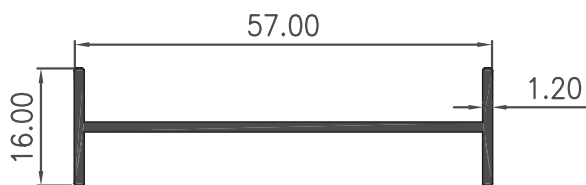

**Section No : 5035**  
W = 0.281 KG/M  
P = 174.57 MM

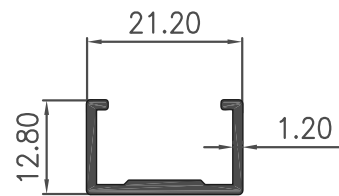

**Section No : 5036**  
W = 0.171 KG/M  
P = 96.72 MM



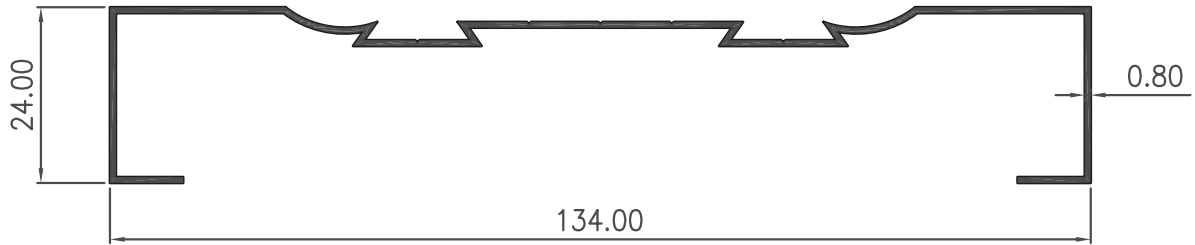

**Section No : 6636**

W = 0.472 KG/M  
P = 439.42 MM

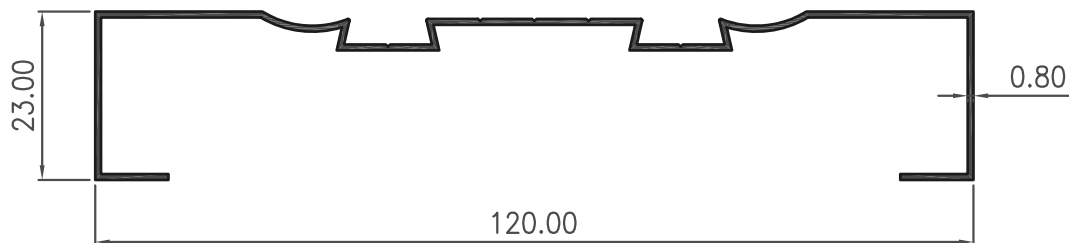

**Section No : 6637**

W = 0.434 KG/M  
P = 403.95 MM

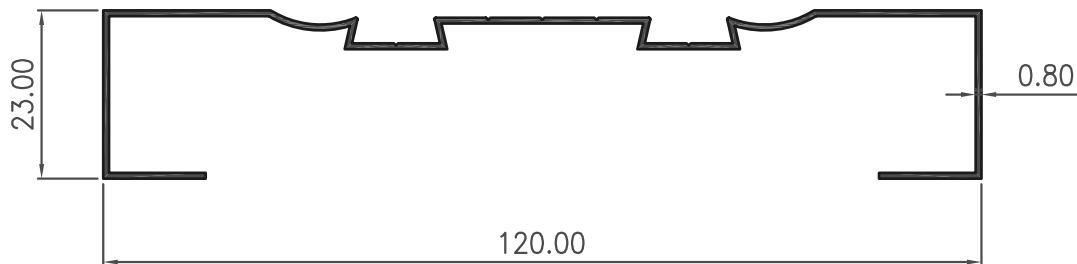

**Section No : 6637R**

W = 0.452 KG/M  
P = 419.95 MM

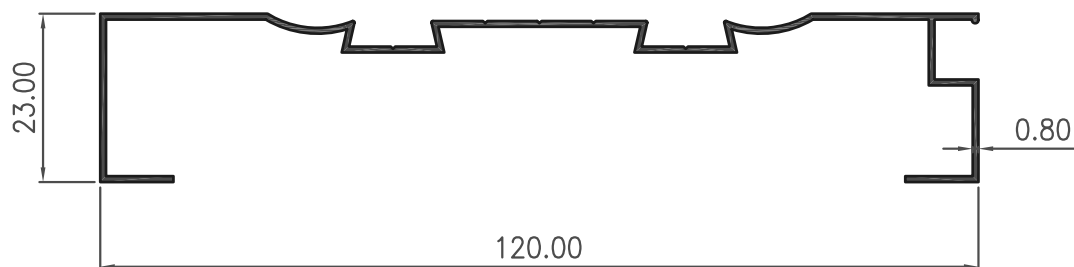

**Section No : 6638**

W = 0.448 KG/M  
P = 416.57 MM

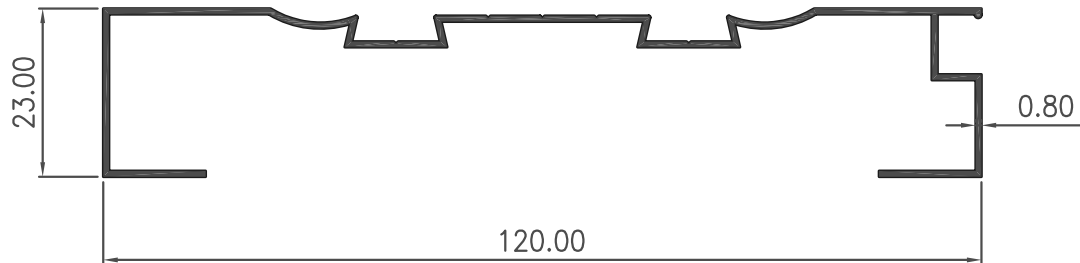

**Section No : 6638R**

W = 0.466 KG/M  
P = 432.57 MM

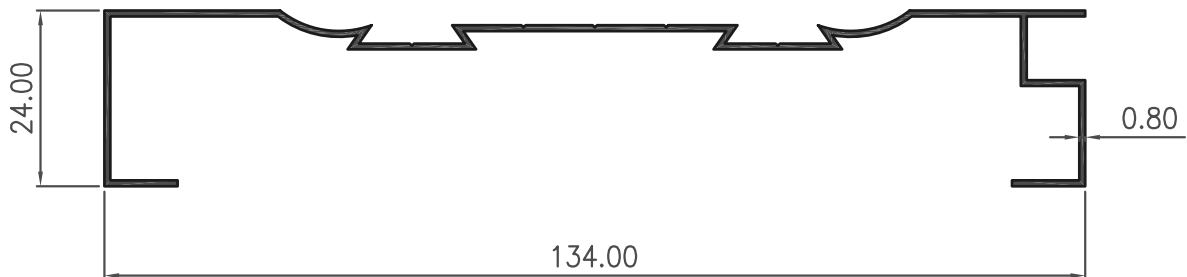

**Section No : 6639**

W = 0.489 KG/M  
P = 455.42 MM

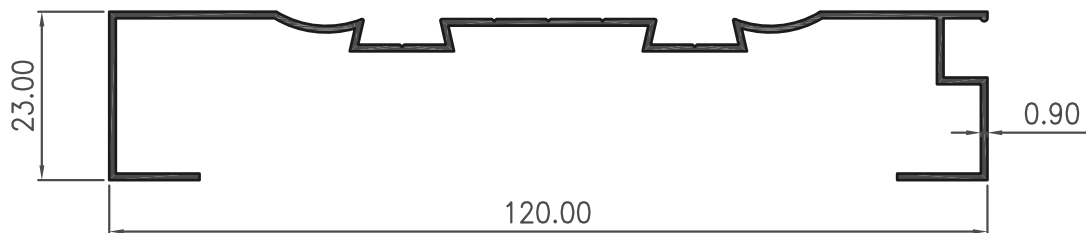

**Section No : 6640**

W = 0.514 KG/M  
P = 425.04 MM

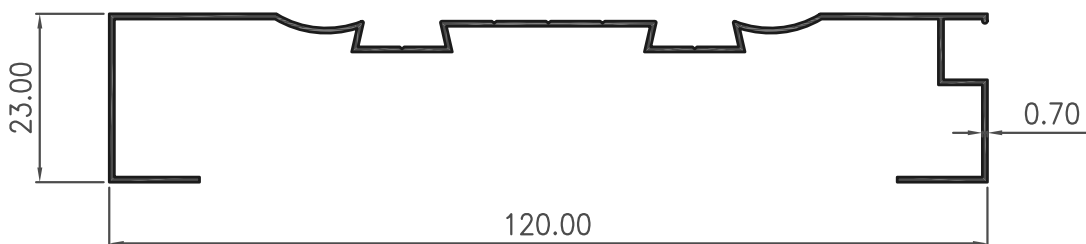

**Section No : 6640R**

W = 0.402 KG/M  
P = 426.99 MM

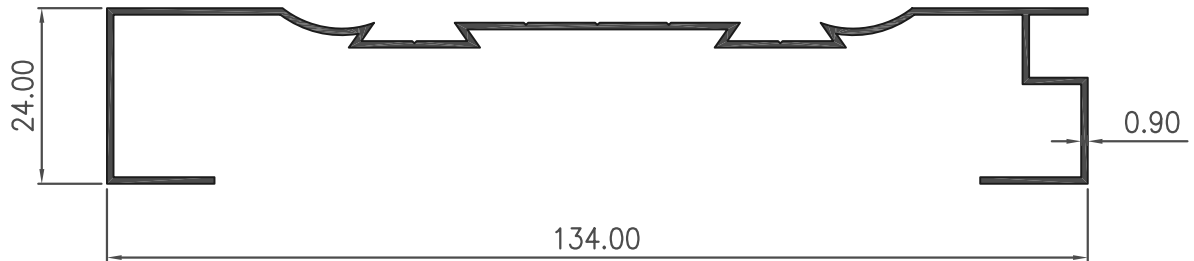

**Section No : 6641**

W = 0.572 KG/M  
P = 473.45 MM

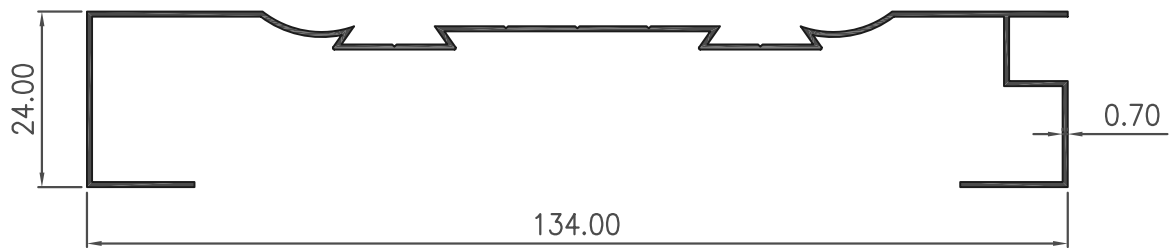

**Section No : 6641R**

W = 0.446 KG/M  
P = 473.68 MM

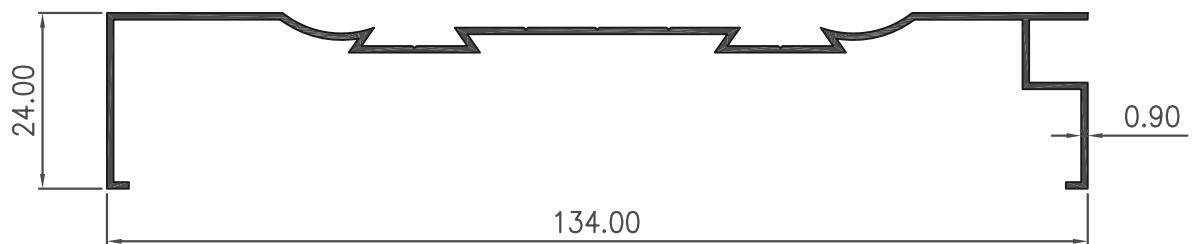

**Section No : 6641A**

W = 0.515 KG/M  
P = 426.65 MM

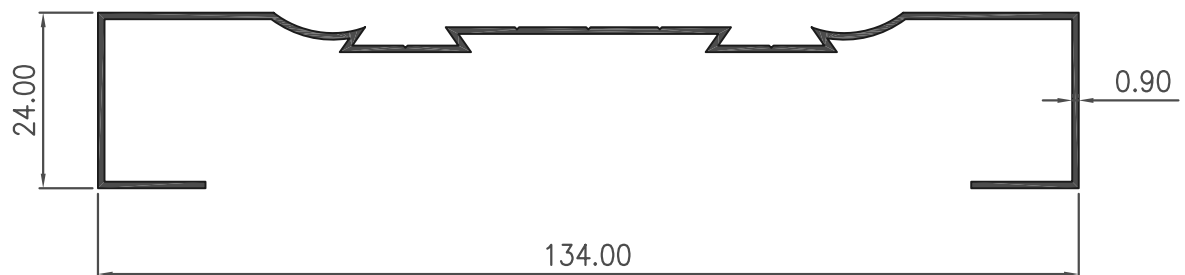

**Section No : 6642**

W = 0.552 KG/M  
P = 457.45 MM

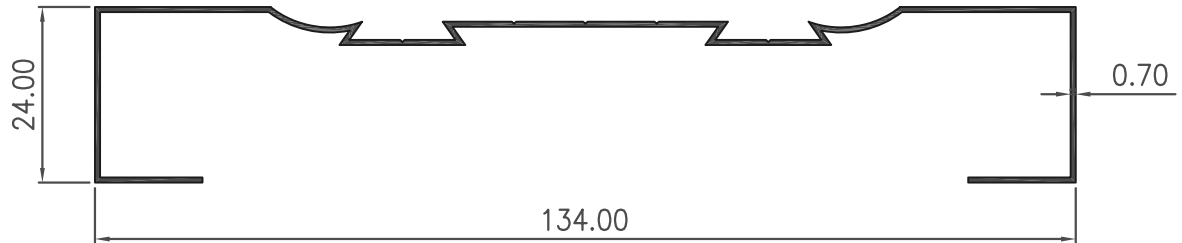

**Section No : 6642R**

W = 0.431 KG/M

P = 459.01 MM

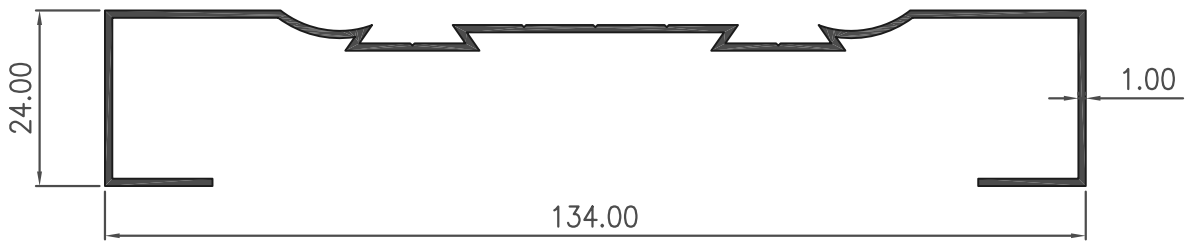

**Section No : 6642A**

W = 0.613 KG/M

P = 456.70 MM

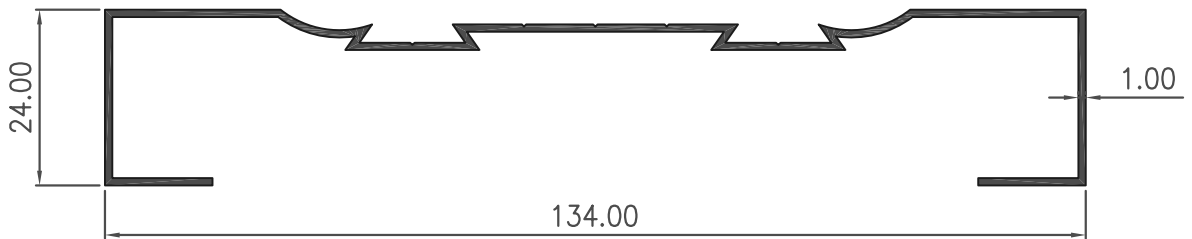

**Section No : 6642A**

W = 0.613 KG/M

P = 456.70 MM

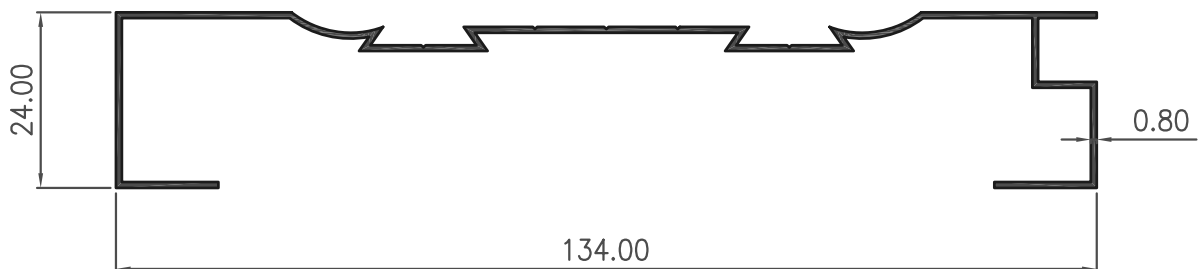

**Section No : 6644**

W = 0.506 KG/M

P = 471.42 MM